



KAWI JAYA MAKMOER

PRODUCT CATALOG





Table of Contents

Aluminium **6**

- Aluminium Talang

Baut **7 - 11**

- Baut Drywall
- Baut Kalsiboard
- Baut SDS
- Baut SDS Conwood (CW)
- Baut SDS Wood

Galvalum **12 - 21**

- Gajamada Galvalum Biru Resin
- Gajamada Galvalum PPGL
- Gajamada Galvalum Silver
- Gajamada Galvalum SRM
- Gajamada Genteng Galvalum
- Galvalum Talang
- Reng
- Hollow
- Canal



Table of Contents

Kawat

22 - 27

- Bendrat
- Bronjong
- Kawat Duri
- Kawat Harmonika
- Kawat Locket HD
- Kawat Locket Hijau
- Kawat Locket Silver
- Kawat Seng

Paku

28 - 34

- Paku Beton Concrete
- Paku GC (General & Common)
- Paku Gypsum
- Paku Kalsiboard
- Paku Kapal
- Paku Mini
- Paku Multiroof
- Paku Nail 2000
- Paku Panda
- Paku Seng
- Paku Seng Ulir
- Paku SuperQ
- Paku Tembak | Coil Nail Gun 2000
- Paku Ulir UCP



Table of Contents

PVC **35 - 36**

- Cocoplas
- Maxel Roof
- Talang Karet Alumplas
- Talang Karet G-Coin
- Talang Karet Komodo

Seng **37 - 39**

- Seng Gelombang
- Seng Plat
- Seng Talang

Tali **40 - 41**

- Tali Rafia
- Tali Tampar

Lain-Lain **42 - 43**

- Begel
- Gerobak YE-ER
- Tangki Air Stainless Steel RX

ALUMINIUM TALANG

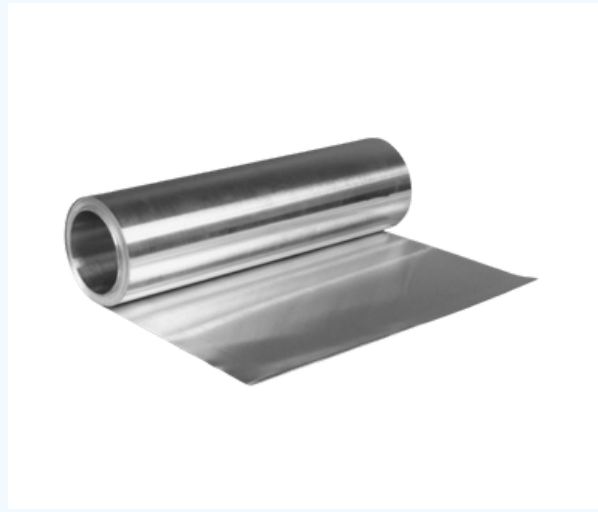

ALUMINIUM TALANG

BAHAN: ALUMINIUM
WARNA: SILVER
PANJANG: 50 M/ ROLL

ALUMINIUM TALANG

Aluminium talang memiliki berbagai keunggulan seperti: ringan, kuat, tidak mudah terbakar, anti karat, anti rayap, anti jamur, mudah dibentuk, dan dapat di daur ulang.



Kawi Facts

Ukuran Aluminium Talang

20 X 100

30 X 60

30 X 100

40 X 60

40 X 100

BAUT DRYWALL



BAUT DRYWALL

MEREK: JMS
BERAT: 20 KG/DUS
DALAM DUS TERDAPAT 20 BOX KECIL
BERAT: 1 KG/ BOX KECIL



BAUT DRYWALL

Baut Drywall kerap digunakan untuk instalasi panel dinding, langit-langit, dan atap. Baut Drywall cocok digunakan untuk material-material seperti rangka tiang kayu, gypsum, PVC, eternit, logam, dan galvalum.



Kawi Facts

Ukuran Baut Drywall

6 X 3/4

6 X 1

6 X 1 1/4

6 X 1 1/2

6 X 2

8 X 3

BAUT KALSIBOARD



BAUT KALSIBOARD

MEREK: JMS

BERAT: 20 KG/DUS

DALAM DUS TERDAPAT 20 BOX KECIL

BERAT: 1 KG/ BOX KECIL



BAUT KALSIBOARD

Baut Kalsiboard kerap digunakan untuk instalasi panel dinding, langit-langit, dan atap. Baut Kalsiboard cocok digunakan untuk material-material seperti kayu, gypsum, pvc, kalsiboard, dan galvalum.



Kawi Facts

Ukuran Baut Kalsiboard

Size	Total Baut Per Dus
6 X 3/4	30.000 PCS
6 X 1	20.000 PCS

BAUT SDS (SELF DRILLING SCREW)

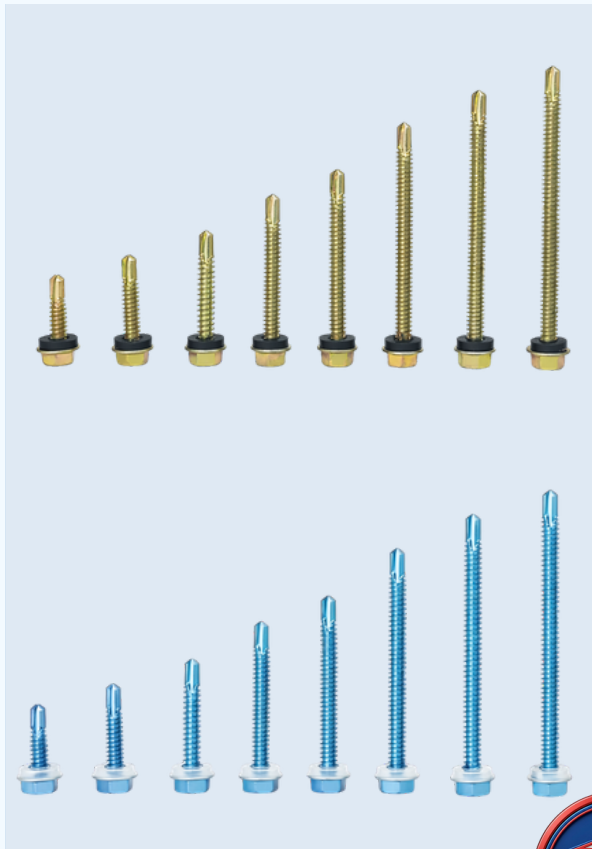

BAUT SDS

MEREK: JMS & YKY
DALAM DUS TERDAPAT 10 BOX KECIL
ISI INNERBOX: TERGANTUNG
MASING-MASING UKURAN BAUT

BAUT SDS

Baut SDS (Self Drilling Screw) memiliki ujung “model mata bor” yang dapat mengebor sendiri lubang pilotnya.

Baut SDS biasa digunakan untuk mengunci rooftop dengan fondasinya.



Ukuran Baut SDS

Diameter	Badan Baut (mm)	Total Baut Per Dus
10	16	13.000
10	19	11.000
12	20	8.500
12	25	7.000
12	30	6.500
12	40	5.000
12	45	4.500
12	50	3.500
12	60	3.500
12	70	2.500
12	75	2.500



Kawi Facts

BAUT SDS CONWOOD (CW)



BAUT SDS CONWOOD

MEREK: JMS

BERAT: 20 KG/DUS

DALAM DUS TERDAPAT 20 BOX KECIL

BERAT: 1 KG/ BOX KECIL



BAUT SDS CONWOOD

Baut SDS CW kerap digunakan untuk instalasi panel dinding, langit-langit, atap, dan lisplang. Baut SDS CW cocok digunakan untuk material-material seperti conwood, kayu, gypsum, pvc, kalsiboard, dan galvalum.



Kawi Facts

Ukuran Baut SDS CW

Size	Total Baut Per Dus Besar
6 X 20	27.000 PCS
6 X 25	21.000 PCS
6 X 32	15.000 PCS
8 X 20	24.000 PCS
8 X 25	17.000 PCS
8 X 32	12.000 PCS

BAUT SDS WOOD



BAUT SDS WOOD

MEREK: JMS

BERAT: 20 KG/DUS

DALAM DUS TERDAPAT 20 BOX KECIL

BERAT: 1 KG/ BOX KECIL



BAUT SDS WOOD

Baut SDS Wood kerap digunakan untuk instalasi antara material kayu dengan kayu atau kayu dengan material lain. Dapat digunakan pada rangka atap, decking, atau struktur kayu yang lain.



Kawi Facts

Ukuran Baut SDS WOOD

Size	Total Baut Per Dus Besar
12 X 50	3.000
12 X 75	2.250



PERBANDINGAN BAUT

	BAUT SDS CW	BAUT KALSIBOARD	BAUT DRYWALL	BAUT SDS
Plafon Gypsum	✓	✓	✓	✗
Plafon Kalsiboard	✓	✓	✗	✗
Plafon PVC	✓	✓	✓	✗
Rangka Galvalum	✓	✓	✓	✓
Rangka Kayu	✓	✓	✓	✗
Fitur Lainnya	Instalasi Lisplang		Instalasi Engsel	Intalasi Atap Exterior
Detail Produk				

GALVALUM BIRU RESIN

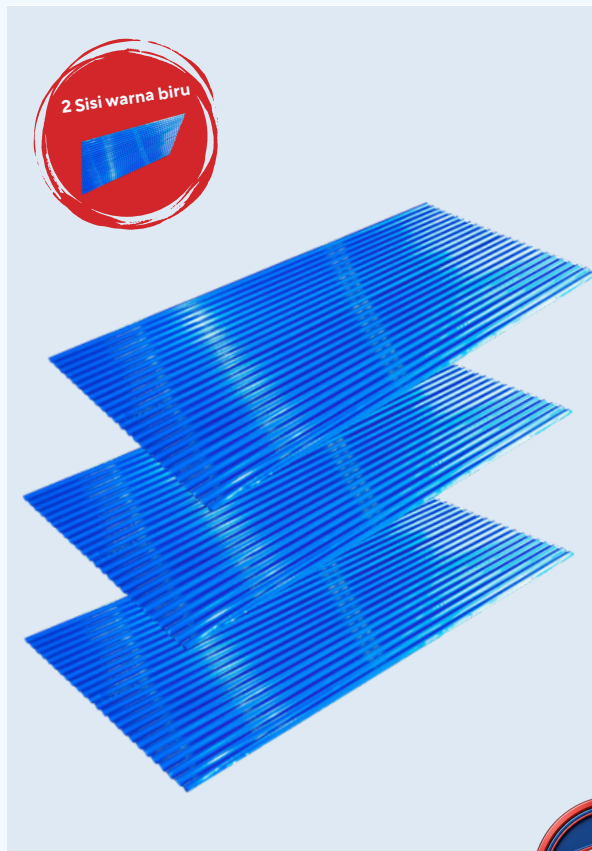

GALVALUM BIRU RESIN

MEREK: GAJAMADA
PANJANG (CM): 180, 210, 240, 300
LEBAR: 80 CM
TERIMA CUSTOM PANJANG &
BENTUK GELOMBANG



GAJAMADA GALVALUM BIRU RESIN

Gajamada Galvalum Biru Resin dilapisi dengan resin plastik berwarna biru pada kedua sisi. Pembangunan rumah tanpa plafon menggemari produk ini karena dari dalam rumah, atap terlihat biru and sudah terlapisi sehingga tidak perlu di cat.

Ukuran Galvalum Biru Resin

Ketebalan

25

Panjang

180 CM

Lebar

80 CM



Kawi Facts

GALVALUM PPGL

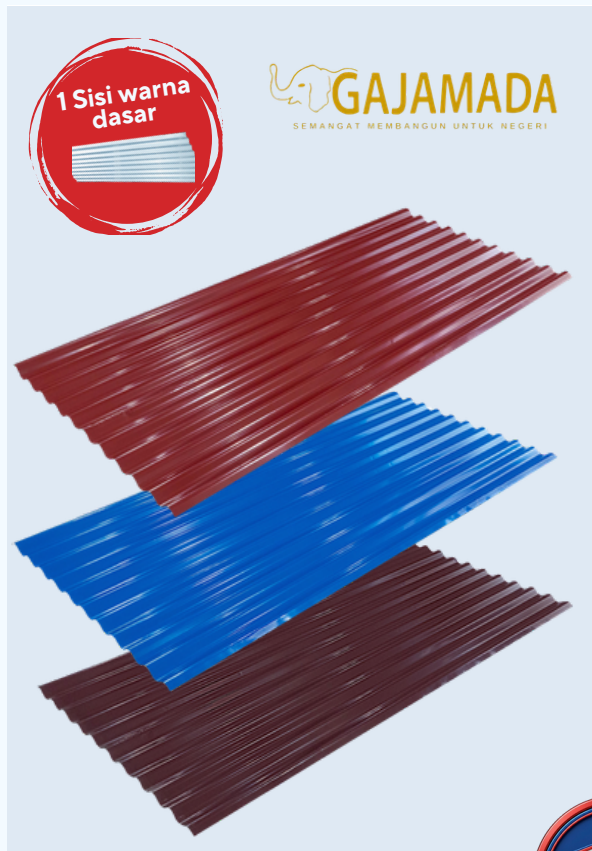

KR 9



K 5



K 9



GALVALUM PPGL

MEREK: GAJAMADA

PANJANG (CM): 180, 210, 240, 300

LEBAR: 80 CM

TERIMA CUSTOM PANJANG & BENTUK GELOMBANG



GAJAMADA GALVALUM PPGL

Gajamada Galvalum PPGL (Pre-painted Galvalume) adalah Aluminum Zinc (AZ) yang dicoating warna. Ready stock untuk gelombang besar dan kecil. Kawi siap melayani custom order bentuk spandek dan panjang gelombang sesuai kebutuhan anda.



Kawi Facts

Varian Galvalum PPGL

Ketebalan

Bentuk

PPGL 25
PPGL 30

GELOMBANG
BESAR
GELOMBANG
KECIL
K5, K9, KR9

Varian Warna



GALVALUM SILVER

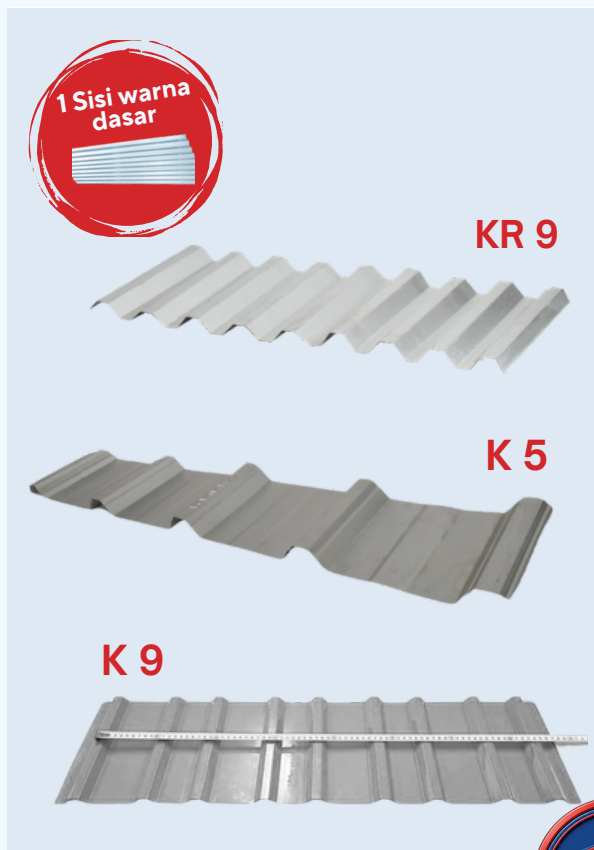

GALVALUM SILVER

MEREK: GAJAMADA
PANJANG (CM): 180, 210, 240, 300,
DAN CUSTOM
LEBAR: 80 CM



GAJAMADA GALVALUM SILVER

Gajamada Galvalum Silver adalah Aluminum Zinc (AZ) berwarna silver. Ready stock untuk bentuk K5, K9, dan KR9. Kawi siap melayani custom order panjang galvalum sesuai kebutuhan anda.

Varian Galvalum Silver

Ketebalan	Bentuk
SILVER 25	K5 (SPANDEK)
SILVER 30	K9 (SOKA)
SILVER 35	KR9 (TRIMDEK
SILVER 40	MINI)



Kawi Facts

GALVALUM SRM



GALVALUM SRM

MEREK: GAJAMADA
PANJANG (CM): 180, 210, 240, 300,
DAN CUSTOM
LEBAR: 80 CM



GAJAMADA GALVALUM SRM

Gajamada Galvalum SRM adalah Aluminum Zinc (AZ) berwarna silver. Ready stock untuk gelombang besar dan kecil. Kawi siap melayani custom order panjang galvalum sesuai kebutuhan anda.

Varian Galvalum SRM

Ketebalan	Bentuk
SRM 25	GELOMBANG BESAR
SRM 30	GELOMBANG BESAR
SRM 35	GELOMBANG KECIL



Kawi Facts



PERBANDINGAN GALVALUM GAJAMADA

Varian	SRM	Silver	PPGL	Biru Resin
Gelombang Besar & Gelombang Kecil	✓	✗	✓	✓
K5, K9, KR9 Spandek, Soka, Trimdek Mini	✗	✓	Custom Order	Custom Order
Warna				
Custom Panjang	✓	✓	✓	✓

GENTENG GALVALUM

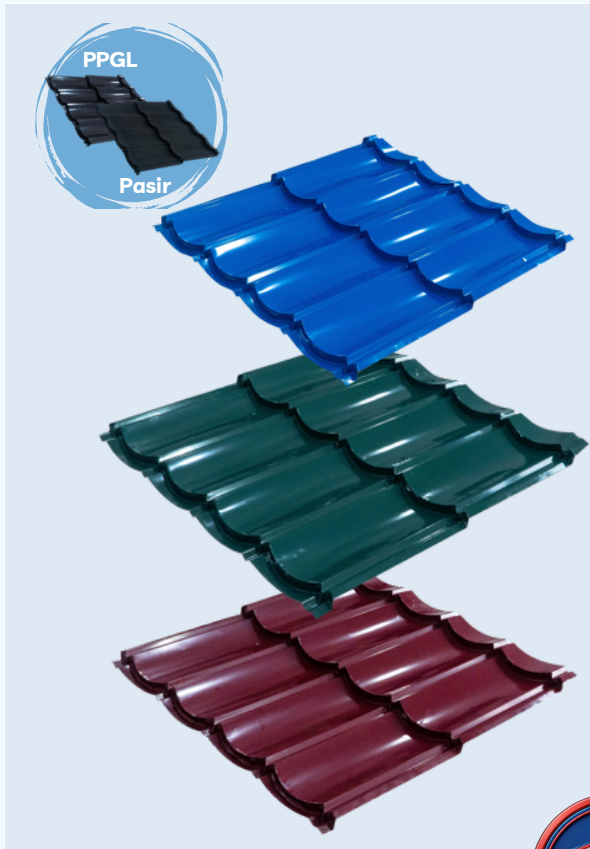

GENTENG GALVALUM

MEREK: GAJAMADA
DIMENSI: 2 LEVEL X 4 DAUN
PANJANG EFEKTIF: 770 MM
JARAK RENG: 385 MM
LEBAR EFEKTIF: 880 MM

GAJAMADA GENTENG GALVALUM

Gajamada Genteng Galvalum adalah Aluminum Zinc (AZ) yang dicoating warna. Ready stock untuk varian PPGL dan Pasir. Tersedia dalam berbagai warna sesuai dengan kebutuhan anda.



Jenis Genteng Galvalum

PPGL

PASIR



Kawi Facts

GALVALUM TALANG



GALVALUM TALANG

MEREK: GAJAMADA
BAHAN: GALVALUM
PANJANG: 50 METER/ROL
VARIAN: TALANG GALVALUM, TALANG GALVALUM BIRU RESIN, TALANG PPGL MARON & BIRU

GAJAMADA GALVALUM TALANG

Talang Gajamada hadir dengan berbagai varian: Seng Talang, Galvalum Talang, Galvalum Talang Biru Resin dan Talang Galvalum PPGL.



Kawi Facts



Ukuran Galvalum Talang

Tebal	Tinggi (CM)	Berat (KG)
20	90	50
25	30	20
25	37	23
25	45	26
25	50	30
25	60	35
25	72	42
25	82	48
25	90	65
25	120	70
30	60	43
30	90	75
40	90	82

CANAL

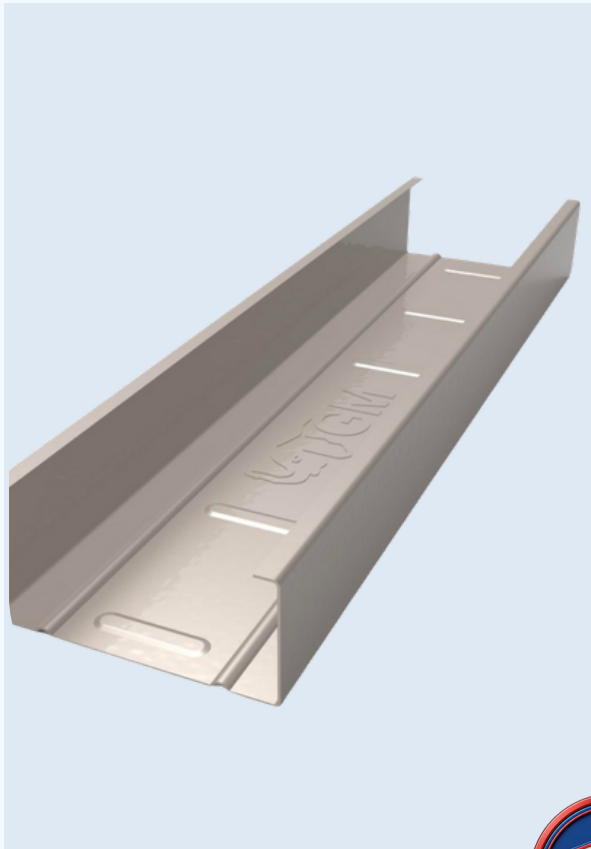

CANAL

MEREK: GAJAMADA
BAHAN: GALVALUM
PANJANG: 6 METER



CANAL

Gajamada Canal, Hollow, dan Reng adalah 3 rangkaian untuk membangun fondasi atap bangunan. Terbuat dari baja ringan yang kuat, tahan lama, dan anti rayap. Pemasangan Canal, Hollow, dan Reng praktis dan mudah.



Kawi Facts

Ukuran Canal

Lebar	Ketebalan	Berat Per Lonjor
75	045	3.2 KG
75	065	4.7 KG

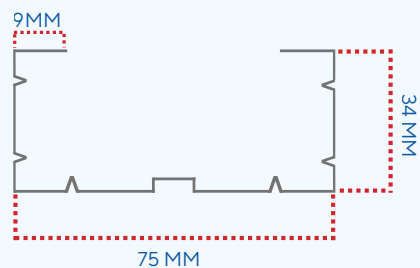

Panjang Canal 6 Meter

HOLLOW

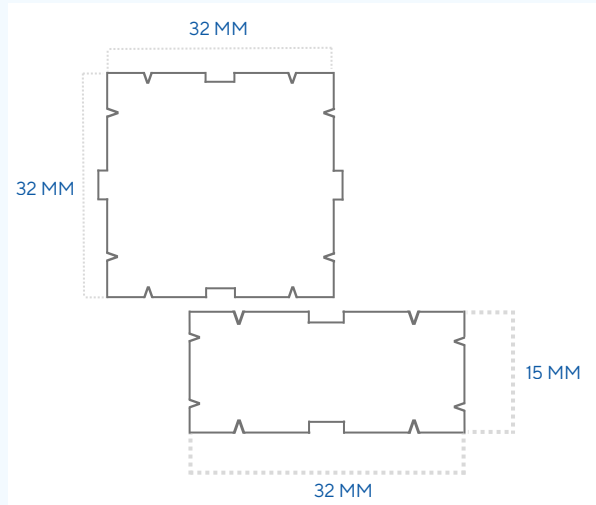

HOLLOW

MEREK: CBM & GAJAMADA

BAHAN: GALVALUM

PANJANG: 4 METER



HOLLOW

Gajamada Canal, Hollow, dan Reng adalah 3 rangkaian untuk membangun fondasi atap bangunan. Terbuat dari baja ringan yang kuat, tahan lama, dan anti rayap. Pemasangan Canal, Hollow, dan Reng praktis dan mudah.



Kawi Facts

Ukuran Hollow

Ketebalan	Ukuran (mm)	Berat Per Lonjor
25	15 X 32	0.56 KG
25	32 X 32	0.72 KG
30	15 X 32	0.66 KG
30	32 X 32	0.86 KG

Panjang Hollow 4 Meter

RENG

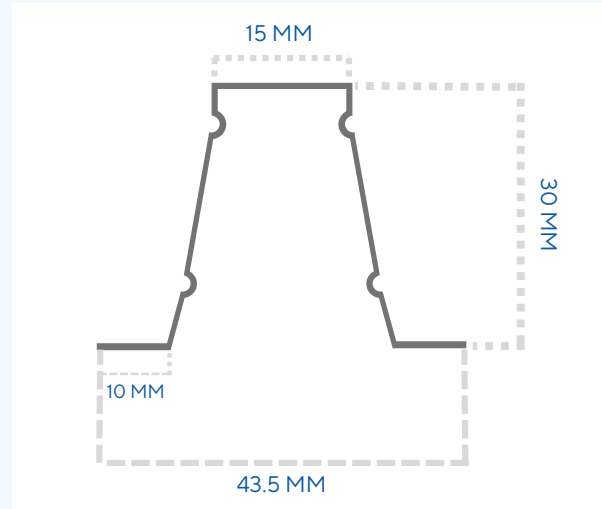

RENG

MERKE: GAJAMADA
BAHAN: GALVALUM
PANJANG: 6 METER



RENG

Gajamada Canal, Hollow, dan Reng adalah 3 rangkaian untuk membangun fondasi atap bangunan. Terbuat dari baja ringan yang kuat, tahan lama, dan anti rayap. Pemasangan Canal, Hollow, dan Reng praktis dan mudah.



Kawi Facts

Ukuran Reng

Ketebalan	Ukuran (mm)	Berat Per Lonjor
30	30	1.4 KG

Panjang Reng 6 Meter

BENDRAT



BENDRAT SUPERPAQ

MERREK: SUPERPAQ

BERAT: 25 KG (5 ROLL @5KG)

INNER PACKING: 5 IKAT @1 KG

DIAMETER BENDRAT: 0.87 MM



BENDRAT MINI

MERREK: NAIL 2000

BERAT: 25 KG (5 ROLL @5KG)

INNER PACKING: 5 IKAT @1 KG

DIAMETER BENDRAT: 0.87 MM



BENDRAT GONI

MERREK: HUA XIN (NAGA)

BERAT: 20 KG & 25 KG

INNER PACKING: TIDAK ADA

DIAMETER BENDRAT: 0.79 - 0.81 MM



BENDRAT



BENDRAT HUA XIN SINGLE

MEREK: HUA XIN (NAGA)

BERAT: 25 KG (5 ROLL @5 KG)

INNER PACKING: 5 IKAT @1KG

DIAMETER BENDRAT: 0.79 - 0.81 MM



BENDRAT IRON

MEREK: NAIL 2000

BERAT: 20 KG

INNER PACKING: TIDAK ADA

DIAMETER BENDRAT: 0.87 MM



BENDRAT KRAWS

MEREK: KRAWS

BERAT: 25 KG (5 ROLL @5KG)

INNER PACKING: 5 IKAT @1 KG

DIAMETER BENDRAT: 0.9 MM



BRONJONG

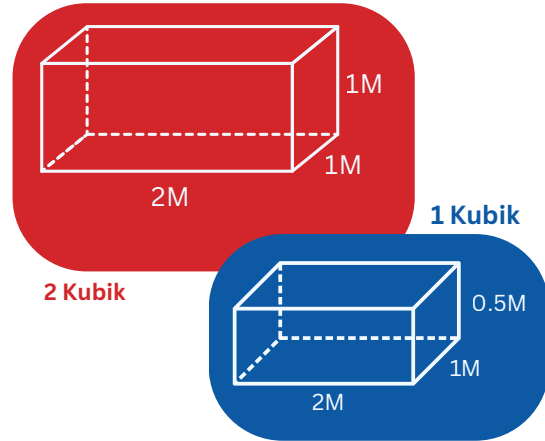
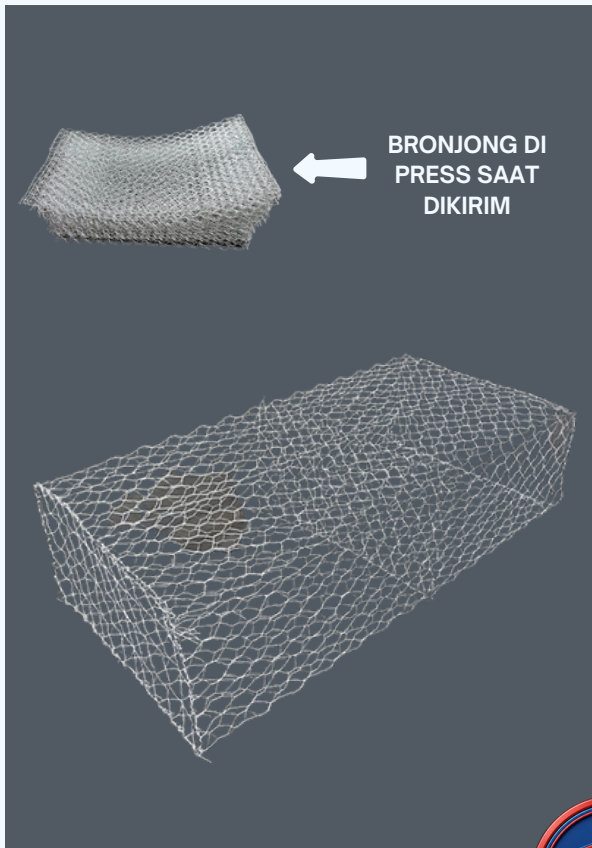

BRONJONG

DIAPRAGHMA: SETIAP 1 METER PANJANG
BAHAN KAWAT: KAWAT HOTDIPPED GALVANIZED Z275
KEMASAN: MIN. 50 LEMBAR
KUAT TARIK: MIN. 41 KG/MM²
ELONGATION: MIN. 12%



BRONJONG

Bronjong adalah kawat struktur yang dianyam dari kawat baja berlapis seng. Penggunaannya dengan diisi batu-batu. Fungsi bronjong untuk menghindari longsor di lereng sungai, lereng tanggul, lereng gunung, dll.

Ukuran Bronjong

Lubang Anyaman	Kawat Anyaman	Tulangan	Tinggi	Kubikasi
8 x 10 cm	2.7 mm	3.4 mm	0.5 m	1 m ³
8 x 10 cm	2.7 mm	3.4 mm	1 m	2 m ³
8 x 10 cm	3.0 mm	4.0 mm	0.5 m	1 m ³
8 x 10 cm	3.0 mm	4.0 mm	1 m	2 m ³
10 x 12 cm	2.7 mm	3.4 mm	0.5	1 m ³
10 x 12 cm	2.7 mm	3.4 mm	1 m	2 m ³
10 x 12 cm	3.0 mm	4.0 mm	0.5 m	1 m ³
10 x 12 cm	3.0 mm	4.0 mm	1 m	2 m ³



Kawi Facts

KAWAT DURI

BAHAN: KAWAT BWG 14 X 14

BERAT: 4 KG/ROL

PANJANG: 40 METER/ROL

CUSTOM: MAX. 10 KG/ROL

Kawat duri digunakan untuk pengaman bangunan, perbatasan negara, dll.



Kawi Facts



KAWAT HARMONIKA

PANJANG: 25 METER/ROL

BWG X RAM: 16 X 30, 16 X 35, 16 X 40, 14 X 40

TERIMA CUSTOM REQUEST TINGGI & PANJANG

Kawat harmonika merupakan kawat yang dianyam dan berbentuk kotak-kotak. Kawat harmonika digunakan untuk pagar sekolah, taman, dll.



Kawi Facts



KAWAT LOKET HIJAU

MEREK: HFT

LEBAR: 0.914 METER

PANJANG: 10 METER/ROL

UKURAN: 1/4", 1/2", 3/4", 1"

Kawat Locket Hijau adalah kawat yang dilapisi dengan pvc warna hijau.



Kawi Facts



KAWAT LOKET SILVER

MEREK: HMI

LEBAR: 0.914 METER

PANJANG: 10 METER/ROL

UKURAN: 1/4", 1/2", 3/4", 1"

Kawat Locket Silver adalah kawat yang dilapisi dengan proses electroplating.



Kawi Facts



KAWAT LOKET HD

MEREK: HMI

LEBAR: 1.2 METER

PANJANG: 50 METER/ROL

UKURAN LUBANG: 2" DAN 3"

Tebal Kawat: 1.1 Mm

Berat: 17.5 Kg (2 inch)

12 Kg (3 inch)



Kawi Facts



KAWAT GONI

MERЕК: HUA XIN (NAGA)
BERAT: BWG 6 - 16 (50 KG)
BWG 18 - 24 (25 KG)
COATING: 30 GR/ METER
KEMASAN: KARUNG GONI



Fungsi: Kawat Bronjong, Kawat Harmonika, Pengikat Konstruksi, Kerajinan Tangan, Pagar BRC.



Kawi Facts

KAWAT HOT DIP

MERЕК: KRAWS
BERAT: 50 KG
COATING: 160 GR/ METER
KEMASAN: PLASTIK HIJAU

Ukuran Kawat

SIZE BWG	DIAMETER KAWAT	SIZE BWG	DIAMETER KAWAT
6	5.10 mm	15	1.83 mm
8	4.20 mm	16	1.65 mm
10	3.40 mm	17	1.47 mm
11	3.00 mm	18	1.25 mm
12	2.75 mm	20	0.90 mm
13	2.41 mm	22	0.70 mm
14	2.10 mm	24	0.60 mm

Fungsi: Kandang Ayam/Kucing, Gantungan Baju, Kawat Duri.



Kawi Facts



PAKU BETON CONCRETE



DMI
CONCRETE NAILS



PAKU BETON CONCRETE

MERЕК: DMI
BERAT: 20 KG PER DUS
INNERBOX: 250 GR
DALAM DUS TERDAPAT 80 BOX KECIL



PAKU BETON CONCRETE

Paku Beton Concrete berfungsi sebagai alat pengencang (fastener) khusus yang dirancang untuk menembus dan mencengkram material keras, terutama beton, blok semen, bata, dan batu. Paku ini terbuat dari baja karbon tinggi yang sangat keras sehingga tidak mudah bengkok.



Kawi Facts

Ukuran Paku Beton Concrete

1"
1 1/4"
1 1/2"
2"
2 1/2"
3"
4 1/2"
5

PAKU GC (GENERAL AND COMMON)



PAKU GC

MEREK: ARROW, HMI, KRAWS, QUEEN
BERAT: ~29.4 KG

PAKU GC

Kawi Jaya Makmoer menyediakan berbagai merek paku sesuai dengan kebutuhan anda. Paku G-C (General & Common) merupakan kategori paku termurah yang KJM sediakan. Paku G-C terdiri dari 4 merek paku yaitu Arrow, HMI, Kraws, dan Queen.



Kawi Facts



Ukuran Paku GC

3/4"

1"

1.1/4"

1.1/2"

1.3/4"

2"

2.1/2" - 6"

PAKU NAIL2000



PAKU NAIL2000

MEREK: NAIL 2000

BERAT: 30.5 KG

INNER BOX:

3/4" - 1 3/4" @2KG

2" - 6" @5KG



PAKU NAIL2000

Kawi Jaya Makmoer menyediakan berbagai merek paku sesuai dengan kebutuhan anda. Paku Nail2000 adalah salah satu paku premium yang KJM sediakan. Paku Nail2000 dipacking dalam box-box kecil agar lebih praktis bagi konsumen.



Kawi Facts

Ukuran Paku Nail2000

3/4"

1"

1.1/4"

1.1/2"

1.3/4"

2"

2.1/2" - 6"

PAKU PANDA

BERAT: 30 KG
INNER BOX: @5KG
POLES: 2X

Paku Panda adalah paku premium. Paku Panda dipacking dalam inner box kecil agar lebih praktis bagi pembeli.



Kawi Facts

PAKU SUPERQ

BERAT: 30 KG
INNER BOX: @5KG
POLES: 2X

Paku SuperQ adalah paku premium. Paku SuperQ dipacking dalam inner box kecil agar lebih praktis bagi pembeli.



Kawi Facts



Ukuran Paku Panda & SuperQ

3/4"

1"

1.1/4"

1.1/2"

1.3/4"

2"

2.1/2" - 6"



PAKU KJM

PERBANDINGAN MEREK PAKU

KATEGORI	PAKU GC	PANDA & SUPERQ	NAIL 2000	PAKU KAPAL 2000
Berat	~29.4 KG	30 KG	30.5 KG	30 KG
Ukuran	3/4" - 6"	3/4" - 6"	3/4" - 6"	1"-6"
Inner Box (5kg)	3/4"-1 3/4"	3/4"- 3"	3/4" - 1 3/4" (2Kg) 2" - 6" (5Kg)	✓
Warna	Silver	Silver	Silver	Gold
Paku Premium	✓	✓	✓	✓
Daya Tahan Karat	★	★★	★★	★★

*Merek Paku General Common (GC) : ARROW, HMI, KRAWS, dan QUEEN



PAKU KAPAL

MERЕК: DMI & NAIL2000

BERAT: 30 KG

UKURAN: 1", 1 1/4", 1 1/2", 2", 2 1/2" - 6"

Kepala paku memiliki ukuran 2.5x lebih besar dari badan paku. Coating Gold 3x lebih tahan lama dari paku kapal silver.



Kawi Facts



PAKU MINI

MERЕК: NAIL 2000 & SUPER PAQ

BERAT: NAIL 2000 9KG & SUPERPAQ 10 KG

INNERBOX: @1 KG

UKURAN: 1/2" & 5/8"

Paku mini pada umumnya digunakan untuk produksi dan reparasi sepatu.



Kawi Facts





PAKU GYPSUM

MERKE: NAIL2000

BERAT: 30KG

UKURAN: 3/4" X 12, 1" X 11, 1 1/4" X 11, 1 1/2" X 11

FUNGSI: INSTALASI INTERIOR LIS PLAFON & PAPAN GYPSUM



PAKU KALSIBOARD

MERKE: DMI & NAIL2000

BERAT: 30KG

INNERBOX: @1KG

UKURAN: 1 X 14"

FUNGSI: INSTALASI ATAP KALSIBOARD, GRC, PLAFON, INTERIOR



PAKU MULTIROOF

MERKE: NAIL2000

BERAT: 30KG

INNERBOX: @5KG

UKURAN: 1 1/4" X 11" & 1 1/2" X 11"

FUNGSI: INSTALASI GENTENG METAL & GENTENG MULTIROOF



PAKU SENG & ULIR



PAKU SENG

MERЕК: DMI & NAIL2000

BERAT: 20 KG

INNERBOX: DMI KEMASAN PLASTIK @1KG & NAIL2000 INNERBOX @1KG

UKURAN: 1 3/4" & 2"

FUNGSI: PEMASANGAN ATAP YANG MEMBUTUHKAN PERLINDUNGAN DARI AIR



PAKU SENG ULIR

MERЕК: DMI

BERAT: 20 KG

INNERBOX: KEMASAN PLASTIK @1KG

UKURAN: 2 1/2", 3", 4"

FUNGSI: INTALASI DI AREA ATAP YANG MEMBUTUHKAN CENGKRAMAN LEBIH KUAT DAN TAHAN TEKANAN ATAU TARIKAN



PAKU ULIR UCP

MERЕК: PANDA

BERAT: 30 KG

UKURAN: 2 1/2" & 3"

FUNGSI: MEMAKU KAYU BENGKIRAI ATAU MEMBUAT PALET KAYU

COIL NAIL GUN 2000

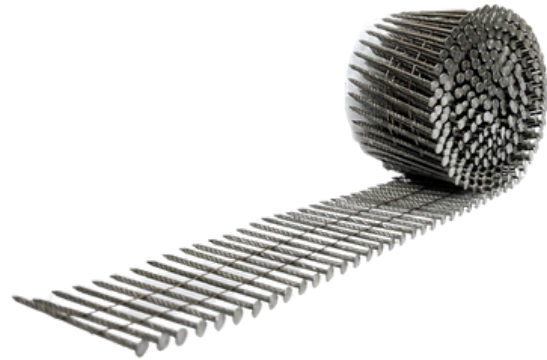
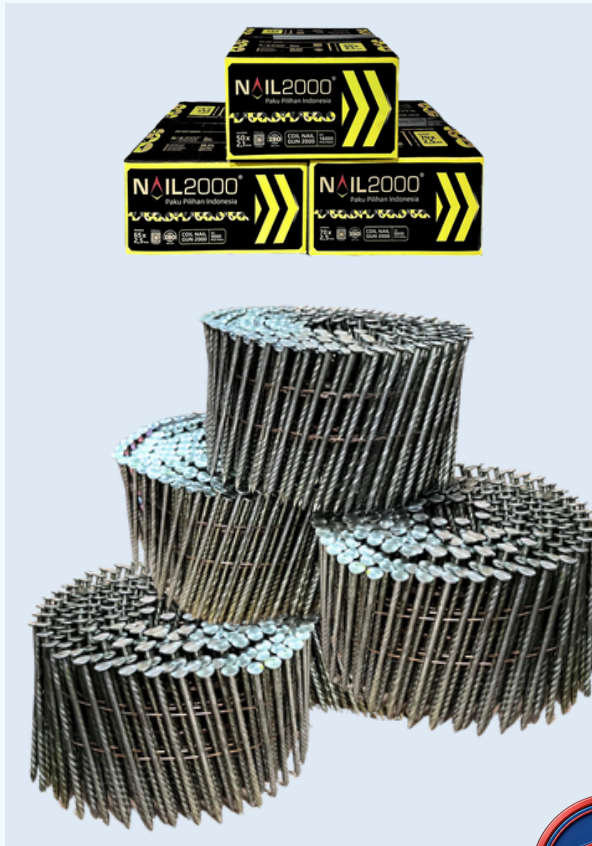

COIL NAIL GUN

MEREK: NAIL 2000

FUNGSI: MEMAKU DENGAN EFISIENSI BIAYA, WAKTU, DAN TENAGA

COIL NAIL GUN 2000

Cara Pemakaian:

- Masukan paku kedalam alat paku tembak
- Rapikan paku sesuai slot
- Tutup Seal Paku
- Paku Tembak siap dipakai



Kawi Facts



Ukuran Coil Nail Gun

Panjang Paku (MM)	Diameter Badan Paku (MM)	Jumlah Paku Per Coil	Jumlah Coil Per Dus	Total Paku Per Dus
50	2.1	400	40	16.000
65	2.5	300	30	9.000
70	2.5	300	30	9.000

COCOPLAS

MEREK: COCOPLAS
PANJANG: 30 METER
UKURAN: BIRU, COKLAT, HIJAU,
PUTIH
TEBAL: 0.60 MM

Cocoplas merupakan fiber plastik yang ditambahkan ke pagar rumah untuk memberi privasi dan keamanan yang lebih.



Kawi Facts

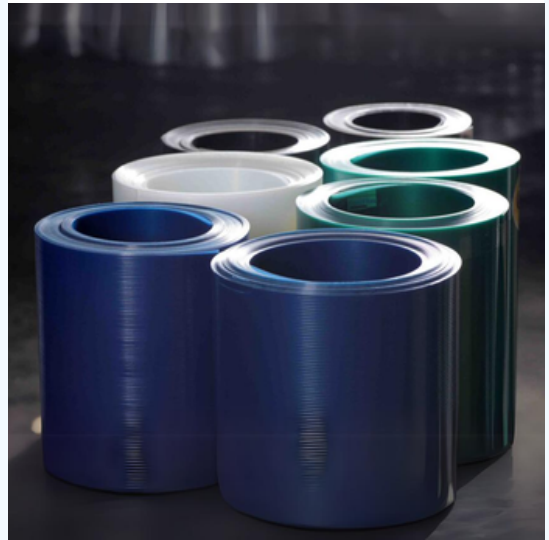

MAXEL ROOF

MEREK: MAXEL ROOF
PANJANG : 180 CM, 210 CM,
240 CM, 300 CM
LEBAR: 80 CM

KETEBALAN

Maxel Roof 0.60 MM
Maxel Plus 0.80 MM
Maxel Premium+ 1.0 MM



Kawi Facts



TALANG KARET



TALANG KARET ALUMPLAS

BAHAN: KARET & ALUMINIUM

TEBAL: ~0.90 MM

UKURAN:

45 CM
50 CM
55 CM
60 CM
70 CM
90 CM
110 CM



TALANG KARET G-COIN

BAHAN: KARET & PLASTIK DAUR ULANG

TEBAL: ~0.80 MM

UKURAN:

45 CM
50 CM
55 CM
60 CM
70 CM
90 CM
110 CM



TALANG KARET KOMODO

BAHAN: KARET & PLASTIK DAUR ULANG

TEBAL: ~0.70 MM

UKURAN:

45 CM
50 CM
55 CM
60 CM
70 CM
90 CM
110 CM

SENG GELOMBANG

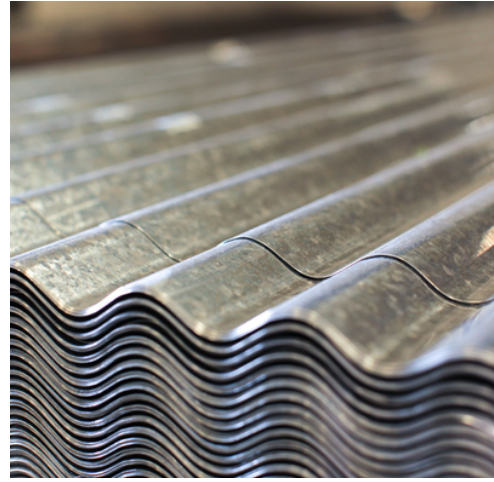
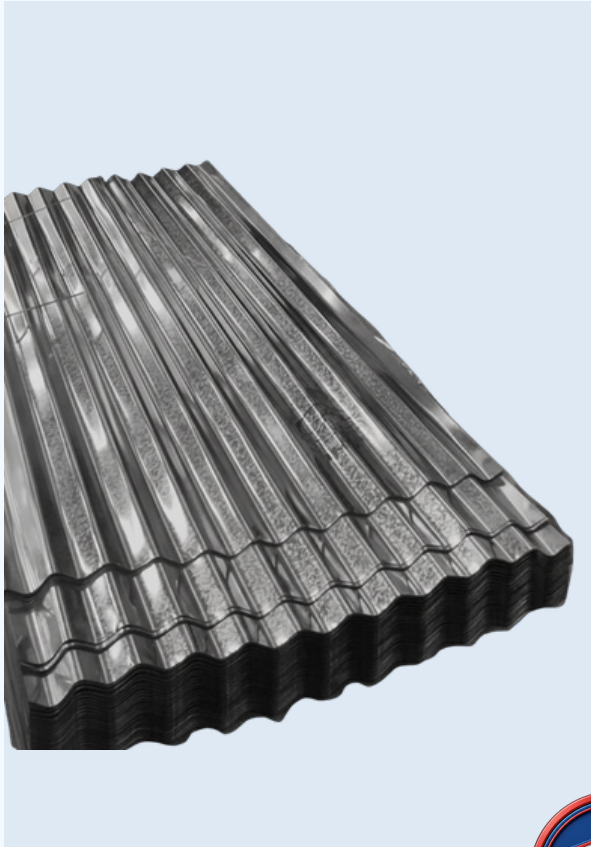

SENG GELOMBANG

MEREK: GAJAH ASIANA PERKASA,
GAJAH & GADING

PANJANG: 180 CM (6 FT), 210 CM (7
FT), 240 CM (8 FT), 300 CM (10 FT)

LEBAR: 80 CM



VARIAN SENG GELOMBANG

Seng gelombang terbuat dari bahan dasar Zinc. Seng gelombang digunakan untuk atap rumah, pagar pembangunan, pagar konstruksi, kandang ternak dll.



Kawi Facts

Ukuran Seng Gelombang

20 X 6 KD BESAR

20 X 6 KD KECIL

20 X 6 BESAR

20 X 6 KECIL

30 X 6 KD

30 X 6 BESAR

40 X 6 BESAR

50 X 6 BESAR

SENG PLAT

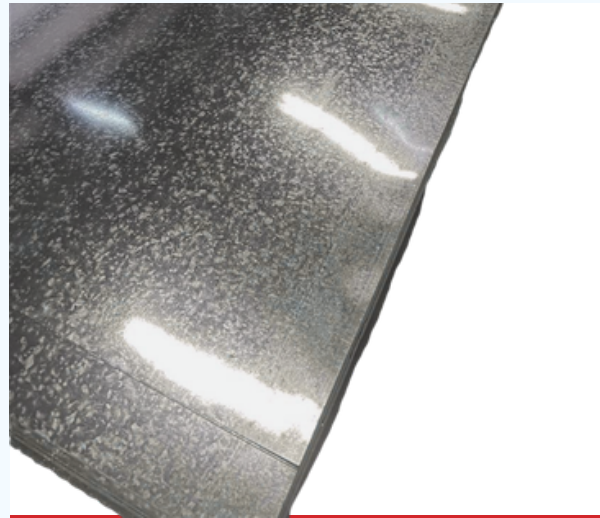

SENG PLAT

MEREK: GAJAH ASIANA

PANJANG: 183 CM

LEBAR: 91 CM



SENG PLAT

Seng plat terbuat dari bahan dasar Zinc. Seng plat digunakan untuk melapisi dinding bangunan karena sifatnya yang tahan air, anti rayap, dan tidak merambatkan api. Seng plat juga dapat digunakan untuk atap balkon/outdoor rumah dan untuk gerobak makanan kaki lima.



Kawi Facts

Ukuran Seng Plat

SENG PLAT H

SENG TALANG

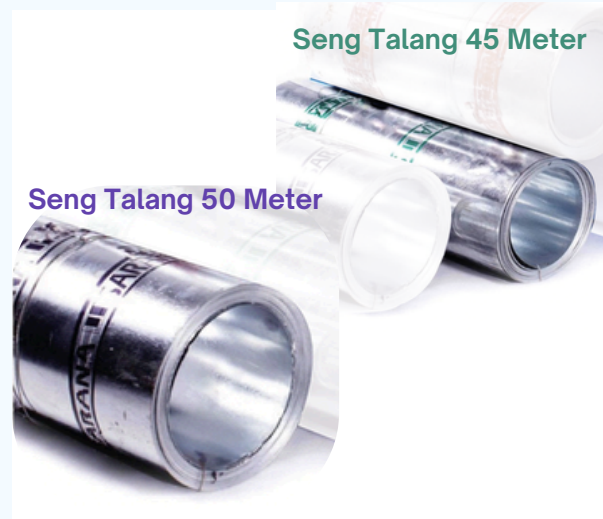

Seng Talang 45 Meter

Seng Talang 50 Meter

SENG TALANG

MERЕК: GAJAMADA

VARIAN: 45 METER DAN 50 METER



SENG TALANG

Talang Gajamada hadir dengan berbagai varian: Seng Talang, Galvalum Talang, Galvalum Talang Biru Resin, dan Galvalum Talang PPGL. Talang Gajamada tersedia dalam berbagai ukuran.



Kawi Facts

Ukuran Seng Talang

Tebal	Tinggi (CM)	Berat (KG)
20	27	16
20	37	22
20	42	25
20	47	27
20	52	30
20	57	33
20	72	42
20	76	44
20	84	49
20	87	50
20	94	54
20	100	58
30	60	70
30	90	82
40	90	145
50	90	158

TALI RAFIA



www.sumberdjajaperkasa.com



SUMBER DJAJA

TALI RAFIA

MEREK: SUMBER DJAJA
PER PACK: 10 ROLL

TALI RAFIA

Tali Rafia memiliki fungsi yang sangat banyak; dapat digunakan untuk industri pertanian, pembangunan, kerajinan tangan, dll.



Ukuran Tali Rafia

1/4 KG

1/2 KG

1 KG



Kawi Facts

TALI TAMPAR



TALI TAMPAR

MEREK: JAGO
MIN. PEMBELIAN 1 KG UNTUK
UKURAN TERTENTU: 1.5 / 2 / 2.5 MM
ESTIMASI JUMLAH ROLL DALAM 1 KG
 1.5 MM: ~9 ROLL
 2 MM: ~5 ROLL



TALI TAMPAR

Tali tamar Jago adalah tali tamar HDPE murni yang berkualitas tinggi. Keunggulan dari tali tamar Jago adalah: flexible, kuat, ringan, mudah disambung, mudah di simpul. Tali tamar digunakan untuk perkebunan, transportasi, kebutuhan industri, dll.



Kawi Facts

Ukuran Tali Tamar

Warna	Ukuran (Mm)	~ Berat/Rol (Kg)	Panjang Per Rol (M)	Jumlah Rol Per Karung	~ Berat/Karung (Kg)
Biru	1.5	0,12	100	231	27,72
	2	0,22		231	50,82
	2.5	0,31		198	61,38
Biru/Hijau/Hijau / Army/Kuning / Orange/Putih	3	1	200	44	44
	4	1,52		32	48,64
	5	2,65		20	53
	6	3,25		16	52
	7	4,55		12	54,60
	8	5,50		8	44
	9	7,80		8	62,40
	10	9		4	36
	12	12,60		4	50,40
	14	17,10		2	34,20
	16	22		2	44
	18	30		1	30
20	35,20	1	35,20		
Biru/Hijau/Kuning/Orange	22	42,10	1	42,10	
	24	50	1	50	

BEGEL

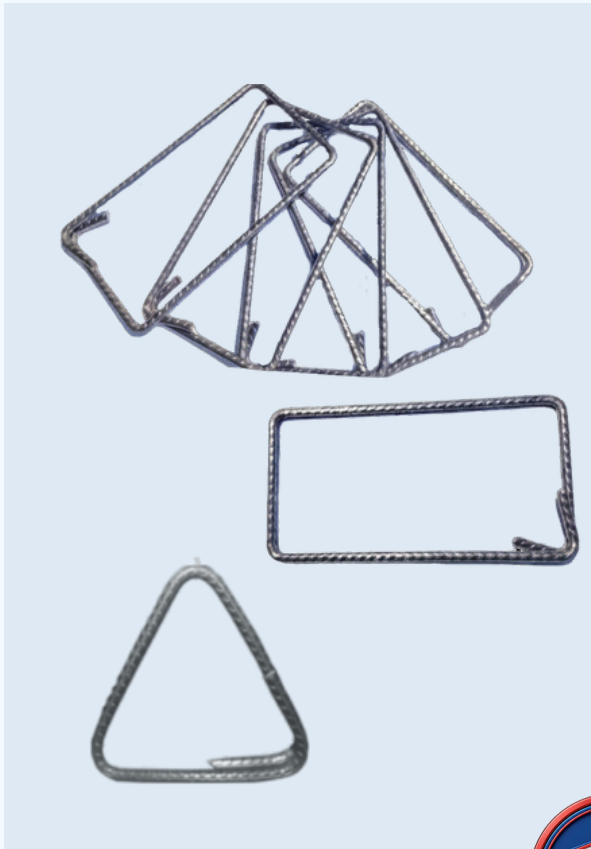

BEGEL

MEREK: BGB

BERAT: 20 KG

TERIMA CUSTOM REQUEST UKURAN

BEGEL

Begel adalah pengikat besi untuk fondasi bangunan untuk mempertahankan posisi besi tulangan.

Keuntungan Begel: Menghemat biaya pembangunan dan waktu tukang untuk membentuk begel tradisional secara satu-persatu.



Ukuran Begel

6 x 10	10 x 10
6 x 12	10 x 12
8 x 8	10 x 15
8 x 10	10 x 20
8 x 12	10 x 25
8 x 15	12 x 12
8 x 20	12 x 15
8 x 25	12 x 30
8 x 27	15 x 15
8 x 30	15 x 20
9 x 9	15 x 25
9 x 10	20 x 20
9 x 12	25 x 25
9 x 15	Tri 8 x 8 x 8
9 x 20	Tri 10 x 10 x 10
9 x 25	



Kawi Facts

GEROBAK YE-ER



GEROBAK YE-ER

MEREK: YE-ER

BERAT: 14 KG

TEBAL PLAT GEROBAK: 1.00 MM

KAPASITAS MAX: 400 KG

WARNA: HAMMERTONE, RED, ORANGE
PURPLE



GEROBAK YE-ER

Gerobak YE-ER dapat digunakan untuk material konstruksi, tambang, perkebunan, dan peternakan. Gerobak YE-ER kuat dan nyaman digunakan.

Ukuran Gerobak YE-ER



Kawi Facts

TANGKI AIR STAINLESS STEEL RX TANK



SUS 304

LS 650

KAPASITAS: 300 LITER
BERAT: 9 KG

INLET, OUTLET, DRAIN
3/4 INCH
TINGGI KAKI: 28 CM



SUS 304

LS 750

KAPASITAS: 400 LITER
BERAT: 11 KG

INLET, OUTLET, DRAIN
3/4 INCH
TINGGI KAKI: 28 CM



SUS 304

LS 1000

KAPASITAS: 650 LITER
BERAT: 15 KG

INLET, OUTLET, DRAIN
3/4 INCH
TINGGI KAKI: 28 CM



SUS 304

LS 1500

KAPASITAS: 1100 LITER
BERAT: 22 KG

INLET, OUTLET, DRAIN
3/4 INCH
TINGGI KAKI: 32 CM



SUS 304

LS 2000

KAPASITAS: 1700 LITER
BERAT: 27 KG

INLET, OUTLET, DRAIN
3/4 INCH
TINGGI KAKI: 32 CM

FREE PLUMBING



KETEBALAN TANGKI AIR SEMUA VARIAN

DINDING: 0.4 MM
ATAS & BAWAH: 0.5 MM

